

## U100M $\varnothing$ 80 - 4,000 mm

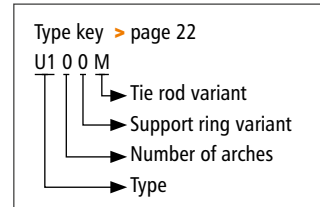

### > Type U100M



### Cross section U100M

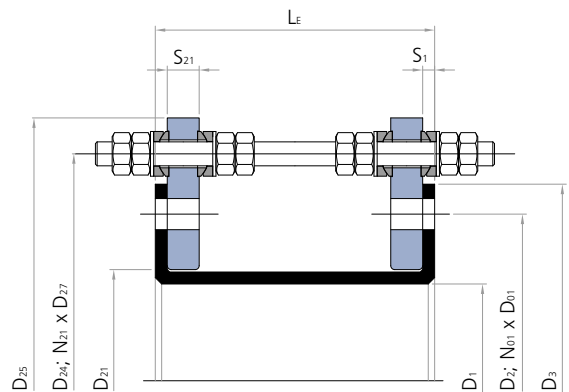

## Lateral expansion joint without arch

**Design:** Streamlined, cylindrical rubber bellows with full faced rubber flanges, have a cycle life in the tens of millions, constructed with a high-grade leak-proof tube, multiple layers of high-strength cord, a seamless cover, and single- or multi-part backing flanges with tie-rods borne in spherical washers. Optional with embedded support rings. In compliance with PED 2014/68/EU, FSA Technical Handbook and ASTM F1123 - 87.

**Diameters:**  $\varnothing$  80 to 4,000 mm, custom diameters possible

**Length:** Standard  $L_E = 150$  to  $400$  mm (> page 204–205)  
Custom length on request

**Pressure:** Up to 16 bar depending on diameter and length  
Vacuum stability on request

**Movement:** For low lateral movements\*







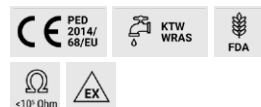













\*Installation gap tolerances according to axial movement capability of the expansion joint

**Application:**  
Plant construction,  
sand/gravel extraction  
industry, dredgers,  
food processing e.g. as  
suction/pressure hoses,  
in conveying lines, on  
pumps and vessels



Request assembly  
instructions at:  
[www.ditec-adam.de/  
en/contact](http://www.ditec-adam.de/en/contact)

## Bellows elastomers and reinforcements

Elastomer	Fabric	Marking	°C	Application
EPDM	Polyamid		-40   +100	Cooling water, hot water, seawater, acids, dilute chlorine compounds
EPDM	Aramid		-40   +100	Cooling water, hot water, seawater, acids, dilute chlorine compounds
EPDMht	Aramid		-40   +120	Cooling water, hot water, seawater, acids, dilute chlorine compounds
EPDMwras	Polyamid		-40   +100	Drinking water, foodstuffs
EPDMwras	Aramid		-40   +100	Drinking water, foodstuffs
EPDMbeige	Polyamid		-40   +100	Foodstuffs
EPDMbeige	Aramid		-40   +100	Foodstuffs
IIR	Polyamid		-20   +100	Hot water, acids, bases, gases
IIR	Aramid		-20   +100	Hot water, acids, bases, gases
CSM	Polyamid		-20   +100	Strong acids, bases, chemicals
CSM	Aramid		-20   +100	Strong acids, bases, chemicals
NBR	Polyamid		-30   +100	Oils, petrol, solvents, compressed air
NBR	Aramid		-30   +100	Oils, petrol, solvents, compressed air
NBRbeige	Polyamid		-30   +100	Oil, fatty foods
NBRbeige	Aramid		-30   +100	Oil, fatty foods
CR	Polyamid		-20   +90	Cooling water, slightly oily water, seawater
CR	Aramid		-20   +90	Cooling water, slightly oily water, seawater
FPM	Aramid		-20   +180	Corrosive chemicals, petroleum distillates
FPMbeige	Aramid		-20   +180	Oil, fatty foods
NR	Polyamid		-20   +70	Abrasive materials
Silicon	Aramid Glass		-60   +200	Air, saltwater atmosphere, foodstuffs, medical technology

PTFE-lining: Firmly embedded against chemical attacks on the interior at the rubber bellows, available starting at  $\varnothing$  300 mm. Take the restriction of the listed movement into account (> page 204–205)

## Backing flanges

- Design:** Single- or multi-part integral backing flanges with clearance holes and tie rod holders (tie rod type B, E, C, M)
- Single- or multi-part backing flanges with clearance holes and tie rod gusset plates (tie rod type R, K, L)
- Flange norms:** DIN, EN, ANSI, AWWA, BS, JIS, special measurements (> page 298)
- Materials:** Carbon steel, stainless steel
- Coating:** Primed, hot-dip galvanised, special paint

## Accessories

- Protective covers:** Ground protective shield  
Protective shield or cover  
Fire protective cover (> page 58)
- Flow liners:** Cylindrical flow liner  
Conical flow liner  
Telescoping flow liner (> page 57)

Tie rods

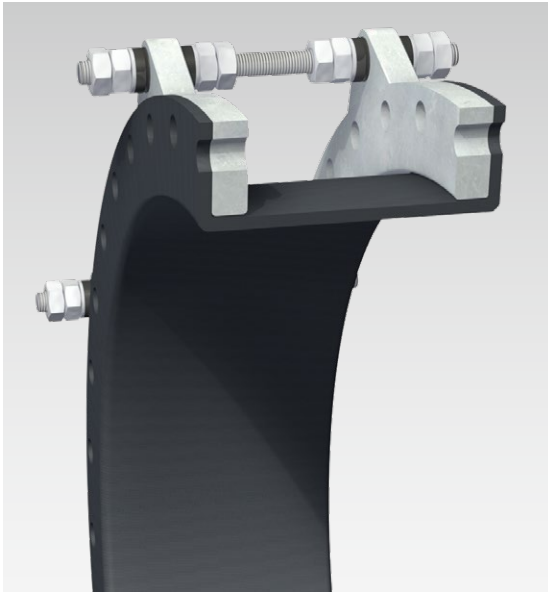

**Design:** Dimensioning according to design pressure (test pressure) based on the Pressure Equipment Directive

**Materials:** Carbon steel  
Stainless steel

**Coating:** Spherical washers/ball disks: PTFE coated  
Tie rods: galvanised, hot-dip galvanised or PTFE-coated

Example: Type U100M

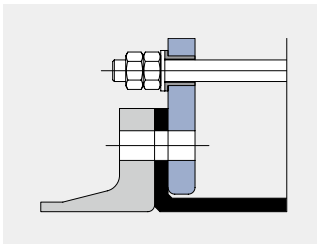

**Type U100B**  
Tie rods mounted outside in rubber bushing to accommodate pressure thrust forces

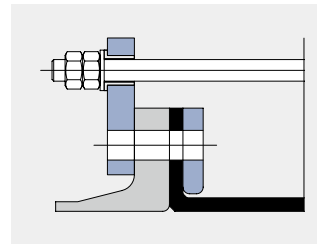

**Type U100R**  
Gusset plates: Tie rods mounted outside in rubber bushing to accommodate pressure thrust forces

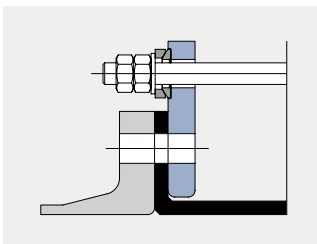

**Type U100E**  
Tie rods mounted outside in spherical washers and ball disks to accommodate pressure thrust forces

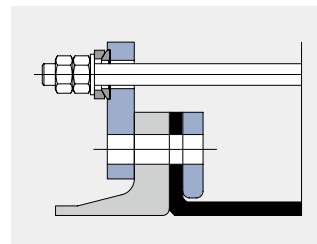

**Type U100K**  
Gusset plates: Tie rods mounted outside in spherical washers and ball disks to accommodate pressure thrust forces

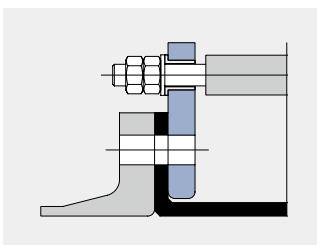

**Type U100C**  
Tie rods mounted outside in rubber bushing and inside with compression sleeve to accommodate pressure thrust forces

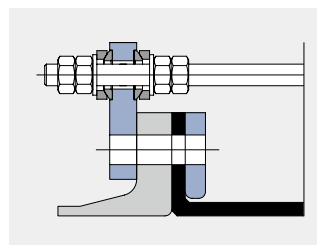

**Type U100L**  
Gusset plates: Tie rods mounted outside and inside in spherical washers and ball disks to accommodate pressure/vacuum thrust forces

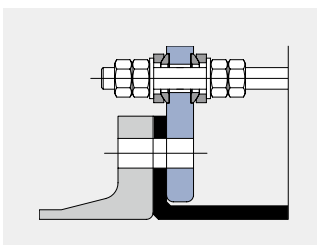

**Type U100M**  
Tie rods mounted outside and inside in spherical washers and ball disks to accommodate pressure/vacuum thrust forces



Large bore lateral rubber expansion joint, type U110M  
GRP pipe  $\varnothing$  3,600 mm of a utility plant  
work-shop hydraulic test at 13 bar

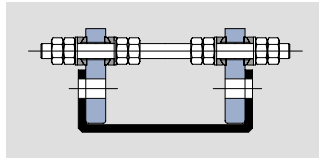

**U100M**  
 > without arch

Installation length (L <sub>E</sub> ) at design pressure															
∅ mm	up to 10 bar L <sub>E</sub> = 150 mm					up to 10 bar L <sub>E</sub> = 200 mm					up to 10 bar L <sub>E</sub> = 250 mm				
	Movement				A cm <sup>2</sup>	Movement				A cm <sup>2</sup>	Movement				A cm <sup>2</sup>
	mm	mm	±mm	±°		mm	mm	±mm	±°		mm	mm	±mm	±°	
100	8	5	10	0	79	10	6	13	0	79	13	8	17	0	79
125	8	5	10	0	123	10	6	13	0	123	13	8	16	0	123
150	8	5	9	0	177	10	6	12	0	177	13	8	15	0	177
175	8	5	9	0	254	10	6	12	0	254	13	8	15	0	254
200	8	5	9	0	314	10	6	12	0	314	13	8	14	0	314
250	8	5	8	0	491	10	6	11	0	491	13	8	14	0	491
300	8	5	8	0	716	10	6	11	0	716	13	8	13	0	716
350	8	5	8	0	990	10	6	10	0	990	13	8	13	0	990
400	8	5	8	0	1,269	10	6	10	0	1,269	13	8	13	0	1,269
450	8	5	7	0	1,612	10	6	10	0	1,612	13	8	12	0	1,612
500	8	5	7	0	1,987	10	6	10	0	1,987	13	8	12	0	1,987
550	8	5	7	0	2,376	10	6	9	0	2,376	13	8	12	0	2,376
600	8	5	7	0	2,856	10	6	9	0	2,856	13	8	12	0	2,856
650	8	5	7	0	3,318	10	6	9	0	3,318	13	8	11	0	3,318
700	8	5	7	0	3,893	10	6	9	0	3,893	13	8	11	0	3,893
750	8	5	7	0	4,418	10	6	9	0	4,418	13	8	11	0	4,418
800	8	5	7	0	5,090	10	6	9	0	5,090	13	8	11	0	5,090
850	8	5	6	0	5,675	10	6	9	0	5,675	13	8	11	0	5,675
900	8	5	6	0	6,433	10	6	9	0	6,433	13	8	11	0	6,433
950	8	5	6	0	7,088	10	6	8	0	7,088	13	8	11	0	7,088
1000	8	5	6	0	7,933	10	6	8	0	7,933	13	8	10	0	7,933
1050	8	5	6	0	8,659	10	6	8	0	8,659	13	8	10	0	8,659
1100	8	5	6	0	9,607	10	6	8	0	9,607	13	8	10	0	9,607
1150	8	5	6	0	10,387	10	6	8	0	10,387	13	8	10	0	10,387
1200	8	5	6	0	11,404	10	6	8	0	11,404	13	8	10	0	11,404
1250	8	5	6	0	12,272	10	6	8	0	12,272	13	8	10	0	12,272
1300	8	5	6	0	13,376	10	6	8	0	13,376	13	8	10	0	13,376
1350	8	5	6	0	14,314	10	6	8	0	14,314	13	8	10	0	14,314
1400	8	5	6	0	15,504	10	6	8	0	15,504	13	8	10	0	15,504
1450	8	5	6	0	16,513	10	6	8	0	16,513	13	8	10	0	16,513
1500	8	5	6	0	17,789	10	6	8	0	17,789	13	8	10	0	17,789
1600	8	5	6	0	20,232	10	6	8	0	20,232	13	8	10	0	20,232
1650	8	5	6	0	21,382	10	6	8	0	21,382	13	8	9	0	21,382
1700	8	5	6	0	22,832	10	6	8	0	22,832	13	8	9	0	22,832
1800	8	5	6	0	25,617	10	6	7	0	25,617	13	8	9	0	25,617
1900	8	5	6	0	28,502	10	6	7	0	28,502	13	8	9	0	28,502
1950	8	5	5	0	29,865	10	6	7	0	29,865	13	8	9	0	29,865
2000	8	5	5	0	31,573	10	6	7	0	31,573	13	8	9	0	31,573
2100	8	5	5	0	34,801	10	6	7	0	34,801	13	8	9	0	34,801
2200	8	5	5	0	38,186	10	6	7	0	38,186	13	8	9	0	38,186
2250	8	5	5	0	39,761	10	6	7	0	39,761	13	8	9	0	39,761
2300	8	5	5	0	41,728	10	6	7	0	41,728	13	8	9	0	41,728
2400	8	5	5	0	45,428	10	6	7	0	45,428	13	8	9	0	45,428
2500	8	5	5	0	49,284	10	6	7	0	49,284	13	8	9	0	49,284
2550	8	5	5	0	51,071	10	6	7	0	51,071	13	8	9	0	51,071
2600	8	5	5	0	53,297	10	6	7	0	53,297	13	8	9	0	53,297
2700	8	5	5	0	57,468	10	6	7	0	57,468	13	8	9	0	57,468
2800	8	5	5	0	61,795	10	6	7	0	61,795	13	8	9	0	61,795
2850	8	5	5	0	63,794	10	6	7	0	63,794	13	8	8	0	63,794
2900	8	5	5	0	66,280	10	6	7	0	66,280	13	8	8	0	66,280
3000	8	5	5	0	70,922	10	6	7	0	70,922	13	8	8	0	70,922
3100	8	5	5	0	75,720	10	6	7	0	75,720	13	8	8	0	75,720
3150	8	5	5	0	77,931	10	6	7	0	77,931	13	8	8	0	77,931
3200	8	5	5	0	80,676	10	6	7	0	80,676	13	8	8	0	80,676
3300	8	5	5	0	85,789	10	6	7	0	85,789	13	8	8	0	85,789
3400	8	5	5	0	91,059	10	6	7	0	91,059	13	8	8	0	91,059
3450	8	5	5	0	93,482	10	6	7	0	93,482	13	8	8	0	93,482
3600	8	5	5	0	102,071	10	6	6	0	102,071	13	8	8	0	102,071
3800	8	5	5	0	113,710	10	6	6	0	113,710	13	8	8	0	113,710
4000	8	5	5	0	125,978	10	6	6	0	125,978	13	8	8	0	125,978

Recommended sizes  
 Further possible sizes

Reduction of movement for expansion joints with PTFE lining:  
 axial compression: -33 %; axial extension: -66 %; lateral displacement: -50 %.  
 Larger movements see type U110x.

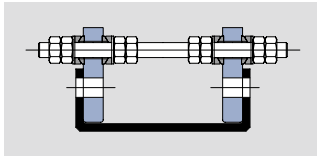

# U100M

> without arch



Installation length (L <sub>E</sub> ) at design pressure															
up to 10 bar L <sub>E</sub> = 300 mm					up to 10 bar L <sub>E</sub> = 350 mm					up to 10 bar L <sub>E</sub> = 400 mm					
higher pressures on request															
Movement				A	Movement				A	Movement				A	∅
mm	mm	±mm	±°	cm <sup>2</sup>	mm	mm	±mm	±°	cm <sup>2</sup>	mm	mm	±mm	±°	cm <sup>2</sup>	
15	9	20	0	79	18	11	23	0	79	20	12	27	0	79	100
15	9	19	0	123	18	11	22	0	123	20	12	25	0	123	125
15	9	18	0	177	18	11	21	0	177	20	12	24	0	177	150
15	9	18	0	254	18	11	21	0	254	20	12	24	0	254	175
15	9	17	0	314	18	11	20	0	314	20	12	23	0	314	200
15	9	17	0	491	18	11	19	0	491	20	12	22	0	491	250
15	9	16	0	716	18	11	19	0	716	20	12	21	0	716	300
15	9	15	0	990	18	11	18	0	990	20	12	21	0	990	350
15	9	15	0	1,269	18	11	18	0	1,269	20	12	20	0	1,269	400
15	9	15	0	1,612	18	11	17	0	1,612	20	12	20	0	1,612	450
15	9	14	0	1,987	18	11	17	0	1,987	20	12	19	0	1,987	500
15	9	14	0	2,376	18	11	17	0	2,376	20	12	19	0	2,376	550
15	9	14	0	2,856	18	11	16	0	2,856	20	12	19	0	2,856	600
15	9	14	0	3,318	18	11	16	0	3,318	20	12	18	0	3,318	650
15	9	13	0	3,893	18	11	16	0	3,893	20	12	18	0	3,893	700
15	9	13	0	4,418	18	11	16	0	4,418	20	12	18	0	4,418	750
15	9	13	0	5,090	18	11	15	0	5,090	20	12	18	0	5,090	800
15	9	13	0	5,675	18	11	15	0	5,675	20	12	17	0	5,675	850
15	9	13	0	6,433	18	11	15	0	6,433	20	12	17	0	6,433	900
15	9	13	0	7,088	18	11	15	0	7,088	20	12	17	0	7,088	950
15	9	13	0	7,933	18	11	15	0	7,933	20	12	17	0	7,933	1000
15	9	12	0	8,659	18	11	15	0	8,659	20	12	17	0	8,659	1050
15	9	12	0	9,607	18	11	14	0	9,607	20	12	16	0	9,607	1100
15	9	12	0	10,387	18	11	14	0	10,387	20	12	16	0	10,387	1150
15	9	12	0	11,404	18	11	14	0	11,404	20	12	16	0	11,404	1200
15	9	12	0	12,272	18	11	14	0	12,272	20	12	16	0	12,272	1250
15	9	12	0	13,376	18	11	14	0	13,376	20	12	16	0	13,376	1300
15	9	12	0	14,314	18	11	14	0	14,314	20	12	16	0	14,314	1350
15	9	12	0	15,504	18	11	14	0	15,504	20	12	16	0	15,504	1400
15	9	12	0	16,513	18	11	14	0	16,513	20	12	16	0	16,513	1450
15	9	12	0	17,789	18	11	14	0	17,789	20	12	15	0	17,789	1500
15	9	11	0	20,232	18	11	13	0	20,232	20	12	15	0	20,232	1600
15	9	11	0	21,382	18	11	13	0	21,382	20	12	15	0	21,382	1650
15	9	11	0	22,832	18	11	13	0	22,832	20	12	15	0	22,832	1700
15	9	11	0	25,617	18	11	13	0	25,617	20	12	15	0	25,617	1800
15	9	11	0	28,502	18	11	13	0	28,502	20	12	15	0	28,502	1900
15	9	11	0	29,865	18	11	13	0	29,865	20	12	15	0	29,865	1950
15	9	11	0	31,573	18	11	13	0	31,573	20	12	15	0	31,573	2000
15	9	11	0	34,801	18	11	13	0	34,801	20	12	14	0	34,801	2100
15	9	11	0	38,186	18	11	13	0	38,186	20	12	14	0	38,186	2200
15	9	11	0	39,761	18	11	12	0	39,761	20	12	14	0	39,761	2250
15	9	11	0	41,728	18	11	12	0	41,728	20	12	14	0	41,728	2300
15	9	11	0	45,428	18	11	12	0	45,428	20	12	14	0	45,428	2400
15	9	10	0	49,284	18	11	12	0	49,284	20	12	14	0	49,284	2500
15	9	10	0	51,071	18	11	12	0	51,071	20	12	14	0	51,071	2550
15	9	10	0	53,297	18	11	12	0	53,297	20	12	14	0	53,297	2600
15	9	10	0	57,468	18	11	12	0	57,468	20	12	14	0	57,468	2700
15	9	10	0	61,795	18	11	12	0	61,795	20	12	14	0	61,795	2800
15	9	10	0	63,794	18	11	12	0	63,794	20	12	14	0	63,794	2850
15	9	10	0	66,280	18	11	12	0	66,280	20	12	14	0	66,280	2900
15	9	10	0	70,922	18	11	12	0	70,922	20	12	13	0	70,922	3000
15	9	10	0	75,720	18	11	12	0	75,720	20	12	13	0	75,720	3100
15	9	10	0	77,931	18	11	12	0	77,931	20	12	13	0	77,931	3150
15	9	10	0	80,676	18	11	12	0	80,676	20	12	13	0	80,676	3200
15	9	10	0	85,789	18	11	12	0	85,789	20	12	13	0	85,789	3300
15	9	10	0	91,059	18	11	11	0	91,059	20	12	13	0	91,059	3400
15	9	10	0	93,482	18	11	11	0	93,482	20	12	13	0	93,482	3450
15	9	10	0	102,071	18	11	11	0	102,071	20	12	13	0	102,071	3600
15	9	10	0	113,710	18	11	11	0	113,710	20	12	13	0	113,710	3800
15	9	10	0	125,978	18	11	11	0	125,978	20	12	13	0	125,978	4000

The movement capability of the expansion joints given in the tables is determined for flange dimensions according to DIN PN10. In case of deviating flange dimensions, please contact us.

Customised products available